

HOLMES

GARAGE DOOR COMPANY®



Glenmoor™ Carriage House 4-Layer
Design 23 with REC13 Windows



LEADERS IN
STYLE ■ SELECTION ■ CRAFTSMANSHIP

Settlers®
Design 13 with SQ24 Windows



Holmes Garage Door Company® offers a complete line of top quality doors including traditional raised panel doors, carriage house style doors, contemporary styles and commercial. With thousands of garage door designs to choose from, Holmes is Making it Easy to find and purchase the right door for your style!

www.holmesgaragedoor.com  MADE IN USA

TABLE OF CONTENTS



Contemporary Aluminum

pgs. 6-7



Contemporary Steel

pgs. 8-9



Glenmoor™ Carriage House
5-LAYER CONSTRUCTION

pgs. 10-11



Glenmoor™ Carriage House
4-LAYER CONSTRUCTION

pgs. 12-13



Glenmoor™ Louver

pgs. 14-15



Glenmoor™ Modern

pgs. 16-17



Settlers®

pgs. 18-19



Artistry® Steel

pgs. 20-21



Westport™ Steel

pgs. 22-23



Lodgewood® Semi-Custom

pgs. 24-25



Decorative Hardware

pgs. 26-27



Standard Steel Gold

pgs. 28-29



Standard Steel Silver

pg. 30



Standard Steel Bronze

pg. 30



Residential Windows

pgs. 32-33



Residential Glass

pgs. 34-35



Commercial Sectional Doors

pgs. 36-37



Commercial Roll-Up Doors

pg. 39

OTHER INFORMATION TO KNOW

Safety, Quality & Innovation pg. 4
 How-To-Measure Information..... pg. 40

intellcore[®] insulation technology

WARMER. QUIETER. STRONGER.

Garage doors featuring Intellcore[®] insulation technology represent the ultimate smart choice for homeowners. Intellcore[®] insulation by Holmes Garage Door Company[®] is a proprietary polyurethane foam that is injected into a garage door, expanding to fill the entire structure. The result is a door with incredible strength and durability. Its dense insulation also produces a quieter door while its industry-leading R-values (up to 20.4) provide year-round comfort and improved energy efficiency.



Look for the Intellcore[®] insulation icon throughout this brochure on select door models.



WARMER

Energy efficiency provides year-round comfort

QUIETER

Dense insulation reduces noise by up to 16 decibels

STRONGER

Enhanced strength resists everyday wear and tear

UPGRADE, PROTECT AND EXTEND THE LIFE OF YOUR GARAGE DOOR

HEAVY HARDWARE UPGRADE

- Nylon ball bearing rollers for quiet, long-lasting operation
- Heavy-duty 14 gauge hinges for smooth worry-free operation



SAFETY, QUALITY & INNOVATION



Deep Embossed Panels

Natural woodgrain texture and detailed raised panel design enhance door's beauty.



Coped Edges

Custom crafted steel doors are designed with stylish beveled, coped edges and decorative center grooves.



Decorative Windows

Inspired by current architectural trends, our windows add a new look to garage doors while complementing your home.



Ultra-Grain[®] Finish

Ultra-Grain[®] finish delivers the best of both worlds—the realism of natural wood with the low maintenance and energy-efficient benefits of insulated steel.



Rust-Prevention System

Unsurpassed rust-prevention system creates a virtually maintenance-free surface.



EZ-SET[®] Torsion Springs

Patented springs for easier, faster and safer installation. Eliminates the labor intensive and dangerous manual winding process.



Standard Steel Gold 6200
with Colonial 509 Windows

3 EASY STEPS TO CHOOSING YOUR NEW DOOR

1 CHOOSE YOUR DOOR STYLE

SPECIALTY OR **STANDARD STEEL**

See page 3 for examples of each door style.

2 CHOOSE YOUR CONSTRUCTION

DOOR CONSTRUCTION

	2" Polyurethane	1-3/8" Polyurethane	2" Polystyrene	1-3/8" Polystyrene	1-5/16" Polystyrene	Steel
FEATURES						
intellicores						
Insulation Rating (R-value)/ Energy Efficiency	18.4*	12.9	9.0	6.5	6.3	N/A
Security						
Noise Control						
Dent Resistance						
Warranty	Limited Lifetime	Limited Lifetime	Limited Lifetime	Limited Lifetime	Limited Lifetime 25-year	Limited Lifetime 15-year

*Glenmor™ R-values range from 6.3 to 20.4. See pages 11, 13, 15 and 17 for more information.

NOTE: Higher R-values mean increased energy efficiency, reduced noise, improved security and durability.
Calculated door section R-value is in accordance with DASMA TDS-163.

3 CUSTOMIZE YOUR DOOR



Colors



Windows



Hardware

CONTEMPORARY ALUMINUM

CONTEMPORARY ALUMINUM garage doors combine aluminum and glass to create a sleek, modern look. Many glass and panel combinations are available for varying degrees of privacy.

DURABLE CONSTRUCTION

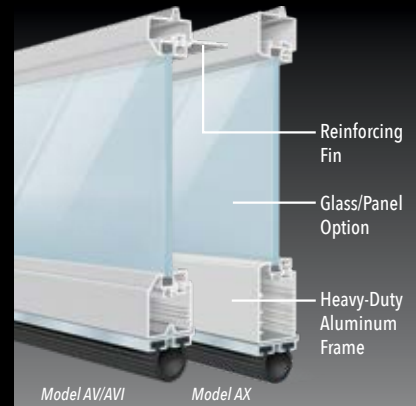

**MODERN DESIGN
VIRTUALLY MAINTENANCE FREE**

Contemporary Aluminum Model AVI with Bronze Frame and Insulated Frosted Glass

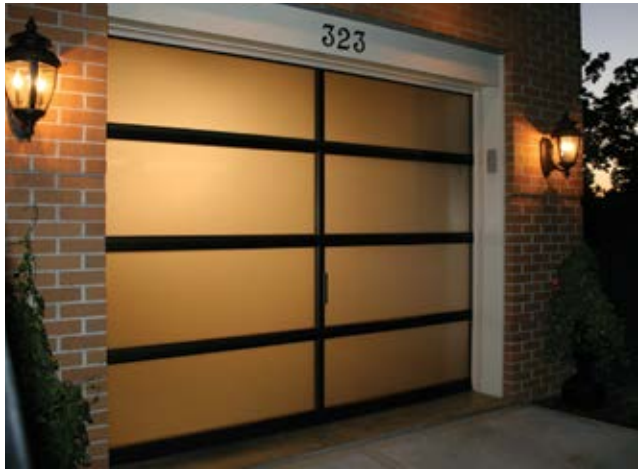

Contemporary Aluminum Model AVI with Anodized Black Frame and Insulated Frosted Glass

CONSTRUCTION AND FINISH

- Durable, low-maintenance 2-1/8" commercial grade aluminum frame with many glazing options.
- Frame and solid aluminum panels available in choice of anodized and powder-coated finishes.
- Tempered full-view glass, acrylic or solid aluminum panel options. Insulated glass garage door panels are available for increased energy efficiency.
- Choose from our selection of aluminum garage door panel colors: White, Bronze, Brown, Clear Anodized, Bronze Anodized, Black Anodized.
- Color-matched aluminum grip handle.
- WindCode® product available.

WARRANTIES



MODELS

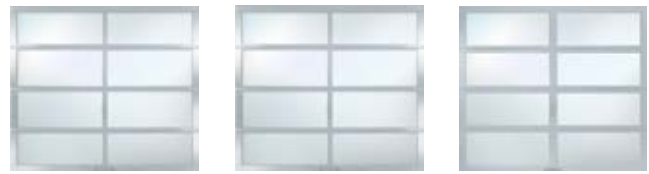

AV (Non-Insulated)

AVI (Insulated)

AX (Insulated and Non-Insulated)

FRAME/SOLID PANEL COLOR OPTIONS

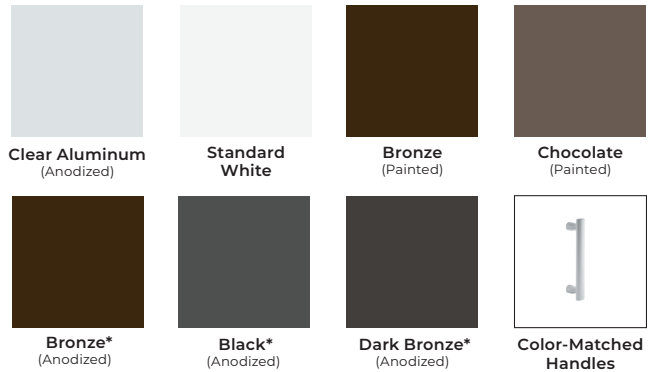

*Colors available at an additional cost.

Due to the anodizing process, slight color variation may occur.

The use of "Bronze (Painted)" is recommended for a more consistent bronze finish color.

Powder coated custom colors available upon request; contact customer service for pricing.

GLASS/PANEL OPTIONS

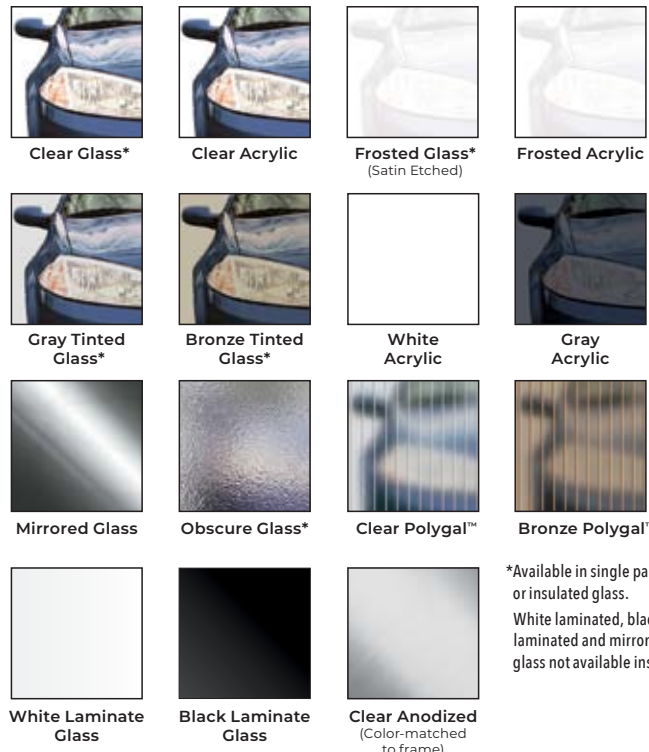

*Available in single pane or insulated glass. White laminated, black laminated and mirrored glass not available insulated.

Panels can be aluminum to match the aluminum frame. Glass/acrylic panels may be combined with aluminum panels. Custom glass and colors available.

Acrylic windows require special cleaning. Never use products that contain ammonia or petroleum products to clean acrylic. Please visit holmesgaragedoor.com/acrylic for complete details.

CONTEMPORARY STEEL

CONTEMPORARY STEEL garage doors complement contemporary and mid-century modern home styles.

THREE-LAYER CONSTRUCTION



Polyurethane or Polystyrene Insulation



MODERN BEAUTY SIMPLE UPKEEP

Contemporary Steel Model 7209 Modern Grooved Panel
in Ultra-Grain® Cypress Cherry Finish

DOOR STYLES

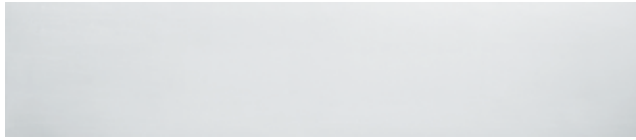

Modern Flush Panel

FLUSH SERIES – Models 7201, 7131, 6201 and 6131

DESIGNER SERIES – Models 7202, 7132, 6202 and 6132

MODERN SERIES – Models 7208, 7138, 6208 and 6138



Modern Grooved Panel

DESIGNER SERIES – Models 7205 and 6205

MODERN SERIES – Models 7209 and 6209

CONSTRUCTION AND FINISH

- Four 3-layer construction types to choose from:
 - 7202, 7201, 7208, 7205 and 7209 have 2" thick Intellicore® polyurethane insulation (18.4 R-value)
 - 7132, 7131 and 7138 have 1-3/8" thick Intellicore® polyurethane insulation (12.9 R-value)
 - 6202, 6201, 6208, 6205 and 6209 have 2" thick polystyrene insulation (9.0 R-value)
 - 6132, 6131 and 6138 have 1-3/8" thick polystyrene insulation (6.5 R-value)
- Many window options available.
- Ultra-Grain® finish available on select three-layer models.

CONTEMPORARY WINDOW OPTIONS



Short Clear Windows
down right side

Long Clear Windows
in all panel locations

Slim Windows
down left side

Available only on Modern Series models.

Contemporary window configurations are available in many design options, including windows in each section and down one side, short, long and slim windows or windows in all sections. For doors with multiple window sections, the window locations must be the same in every section.

Door models offering these configurations utilize 24" and 21" section heights.

NOTE: Contemporary window configurations are described from inside the garage looking out.

WARRANTIES



COLOR OPTIONS



*Not available on all models; contact customer service for availability.

† Popular in select markets, Glacier White is a brighter white. Due to the printing process, colors may vary.

WINDOWS



Clear



Designer Inserts



Architectural Series



Contemporary Slim

Additional window designs available.

See pages 32 and 33 for Flush Series window options.

See page 33 for Designer and Modern Series window options.

GLENMOOR™ CARRIAGE HOUSE 5-LAYER CONSTRUCTION

The natural beauty of wood with the durability and energy-efficient benefits of composite and steel.

FIVE-LAYER CONSTRUCTION



WOOD LOOK WITHOUT THE WOOD MAINTENANCE

Glenmoor™ Carriage House 5-Layer Design 12 with SQ23 Windows

CONSTRUCTION AND FINISH

- Five-layer construction with Intellicore® polyurethane insulated, composite faux wood doors (20.4 R-value). Swing-out appearance – modern operation.
- Available in 15 door designs and 13 window or top sections for multiple door design options.
- Composite cladding options include Clear Cypress, Mahogany and Pecky Cypress. Composite overlay options include Clear Cypress and Mahogany.
- Insulated glass options include clear, frosted, seeded, rain and obscure. See page 35 for specialty glass options.
- Attractive beveled-edge, clip-in grilles are removable for easy window cleaning.
- Premium grade hardware, rollers and track assure smooth, quiet, long-lasting operation.
- Factory finished in Walnut, Dark, Medium, Slate or Black Finish; doors can also be ordered in White Finish (Mahogany only) or primed for homeowners wishing to custom paint or stain their doors.

WARRANTIES



DECORATIVE HARDWARE

INCLUDED



Spade Step Plate



Spade Lift Handles

OPTIONAL



Spear Lift Handles



Spear Step Plate



Keylocks



Spear Strap Hinge



Escutcheon Plates

Additional hardware options are available; see pages 26-27.

COLORS

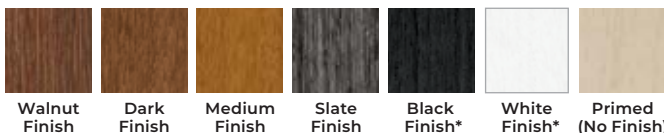

*Black and White Finish available only on Mahogany cladding and overlays.

Doors can be ordered primed for those homeowners wishing to custom paint or stain their doors. Door stain color will vary slightly within a door due to finishing process. Due to the printing process, colors may vary.

DOOR DESIGNS

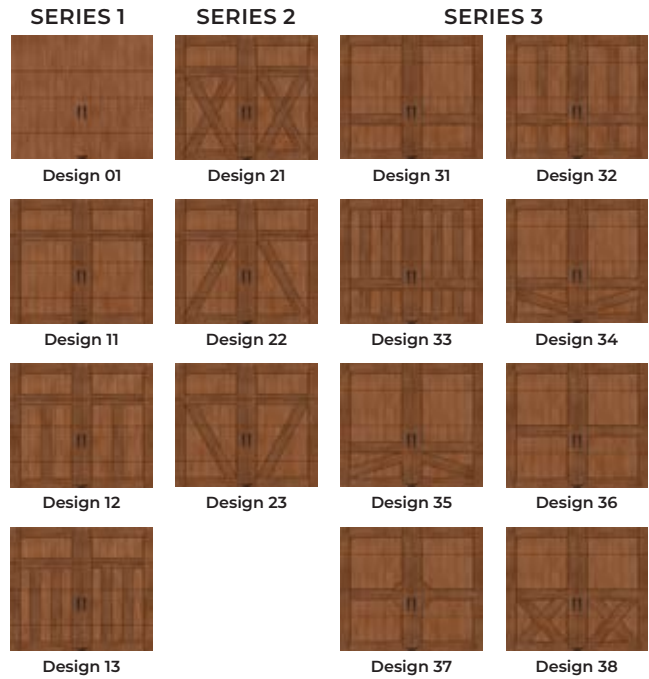

Doors shown in Dark Finish with Clear Cypress composite cladding and Clear Cypress composite overlay. Design 01 does not have an overlay.

WINDOWS/TOP SECTION OPTIONS

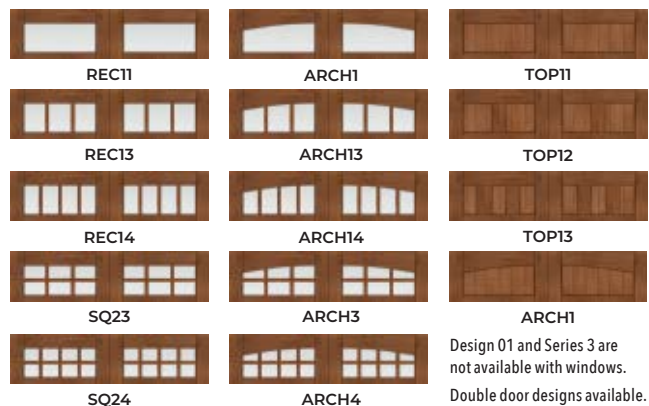

Design 01 and Series 3 are not available with windows. Double door designs available.

MATERIAL DESIGN OPTIONS

CLADDING



OVERLAY



Cladding and overlay material options may be mixed and matched.

GLENMOOR™ CARRIAGE HOUSE 4-LAYER CONSTRUCTION

Insulated carriage house garage doors with faux wood-look overlays on a steel base.

FOUR-LAYER CONSTRUCTION



WOOD LOOK WITHOUT THE MAINTENANCE

Glenmoor™ Carriage House 4-Layer Design 12 with SQ23 Windows

CONSTRUCTION AND FINISH

- Four-layer construction with Intellicore® polyurethane insulated, faux wood doors (18.4 R-value). Swing-out appearance – modern operation.
- Available in 14 door designs and 13 window or top sections for multiple door design options.
- Base steel options include Ultra-Grain® finish in Clear Cypress or solid color steel. Composite overlay available in Clear Cypress or Mahogany.
- Insulated glass options include clear, frosted, seeded, rain and obscure. See page 35 for specialty glass options.
- Attractive beveled-edge, clip-in grilles are removable for easy window cleaning.
- Premium grade hardware, rollers and track assure smooth, quiet, long-lasting operation.

WARRANTIES



DECORATIVE HARDWARE

INCLUDED



Spade Lift Handles



Spade Step Plate

OPTIONAL

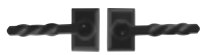

Keylocks



Spear Lift Handles



Spear Step Plate



Escutcheon Plates



Spear Strap Hinge

Additional hardware options are available; see pages 26-27.

DOOR DESIGNS

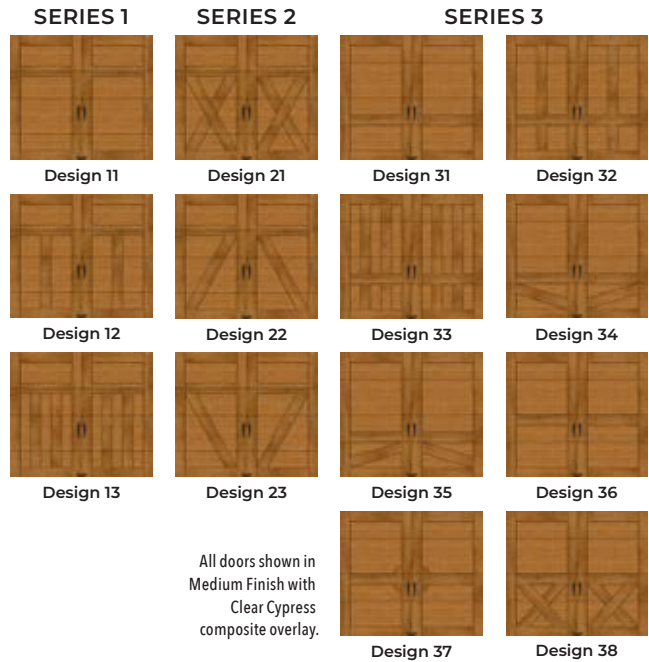

WINDOWS/TOP SECTION OPTIONS

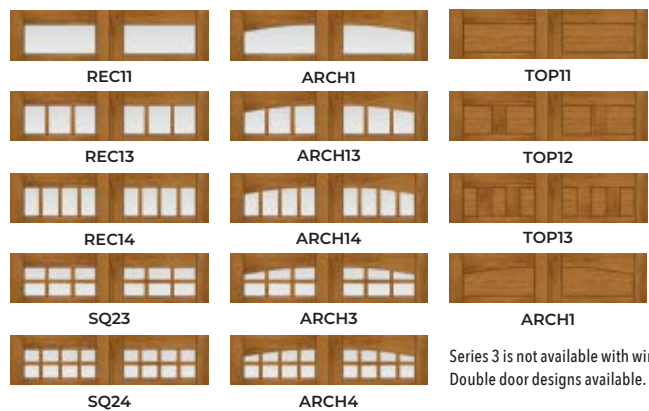

MATERIAL DESIGN OPTIONS

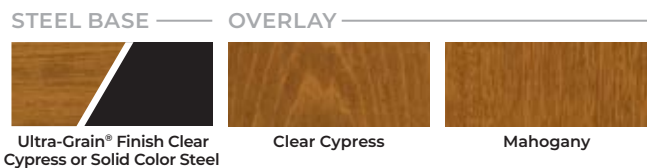

COLORS

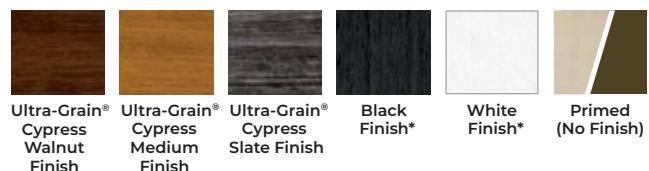

*Black and White Finish available only on Mahogany overlays.

Steel surfaces have woodgrain texture. Doors can be ordered primed for those homeowners wishing to custom paint their doors. Note: Primed solid steel base is a brown color. Door stain color will vary slightly within a door due to finishing process. Due to the printing process, above colors may vary.

GLENMOOR™ LOUVER

Insulated garage doors with composite louver overlays adding charm with plantation shutter style.

FIVE-LAYER CONSTRUCTION



SHUTTER STYLE FOR ANY HOME

Glenmoor™ Carriage House 4-Layer Design 12 with SQ23 Windows

CONSTRUCTION AND FINISH

- Five-layer construction with Intellicore® polyurethane insulated, composite faux wood doors. R-values range from 18.4 to 20.4. Swing-out appearance – modern operation.
- Available in 12 door designs and 6 window or top sections for multiple door design options.
- Cladding/base steel options include Louver Mahogany, Ultra-Grain® finish in Clear Cypress or solid color steel. Composite overlay available in Clear Cypress or Mahogany.
- Insulated glass options include clear, frosted, seeded, rain and obscure. See page 35 for specialty glass options.
- Attractive beveled-edge, clip-in grilles are removable for easy window cleaning.
- Premium grade hardware, rollers and track assure smooth, quiet, long-lasting operation.
- Factory finished in Walnut, Dark, Medium, Slate or Black Finish; door can also be ordered in White Finish (Mahogany only) or primed for homeowners wishing to custom paint or stain their doors.

WARRANTIES



DECORATIVE HARDWARE

INCLUDED

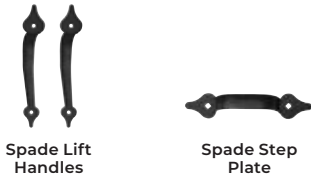

OPTIONAL



Additional hardware options are available; see pages 26-27.

DOOR DESIGNS

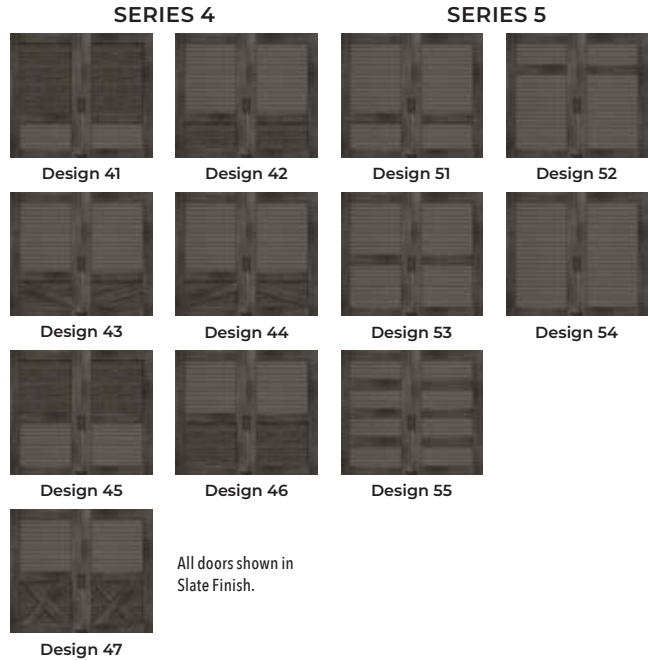

WINDOWS/TOP SECTION OPTIONS



Window grilles are Mahogany texture. Windows available only on Louver Design 52. Standard windows available on the following widths only: 6'2", 8'0", 9'0", 10'0", 10'2", 12'0", 12'2", 13'6", 15'0", 15'2", 15'6", 15'8", 16'0", 16'2", 18'0", 18'2", 20'0", 20'2". To view additional designs, windows and top sections available, please visit www.holmesgaragedoor.com.

MATERIAL DESIGN OPTIONS

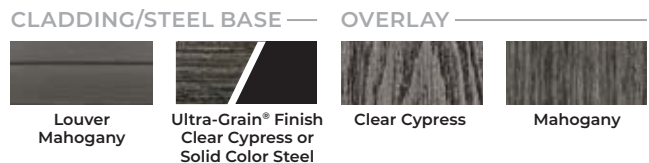

Note: Cladding and overlay material options may be mixed and matched.

COLORS

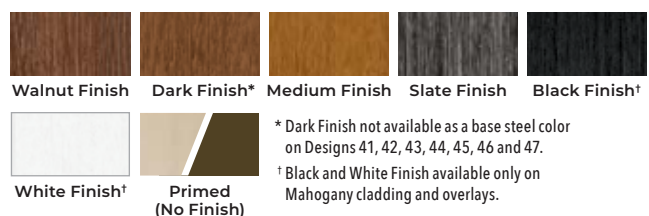

* Dark Finish not available as a base steel color on Designs 41, 42, 43, 44, 45, 46 and 47.

† Black and White Finish available only on Mahogany cladding and overlays.

Steel surfaces have woodgrain texture. Doors can be ordered primed for those homeowners wishing to custom paint or stain their doors. Note: Primed solid steel base is a brown color. Door stain color will vary slightly within a door due to finishing process. Due to the printing process, above colors may vary.

GLENMOOR™ MODERN

A perfect complement to the natural materials and textures on your home's exterior.

FOUR-LAYER CONSTRUCTION



INSULATED MODERN STYLE WITH FAUX WOOD OVERLAYS

Glenmoor™ Modern Metal (Aluminum) Inlay Design in Medium Finish with Mahogany Cladding

CONSTRUCTION AND FINISH

- Three 4-layer designs to choose from:
 - Plank design steel faux wood doors with Intellicore® polyurethane insulation (20.4 R-value)
 - Steel faux wood doors combined with a Metal Inlay design and Intellicore® polyurethane insulation (18.4 R-value)
 - Full-View design steel faux wood doors with Intellicore® polyurethane insulation (6.3 R-value)
- Cladding and overlay options include Mahogany and Clear Cypress.
- Many glass options available including clear, frosted, rain and obscure as well as insulated.
- Premium grade hardware, rollers and track assure smooth, quiet, long-lasting operation.
- Factory finished in Walnut, Dark, Medium, Slate or Black Finish; door can also be ordered in White Finish (Mahogany only) or primed for homeowners wishing to custom paint or stain their doors.

WARRANTIES



DECORATIVE HARDWARE

INCLUDED



Spade Lift Handles



Spade Step Plate

OPTIONAL



Aluminum Grip Handles

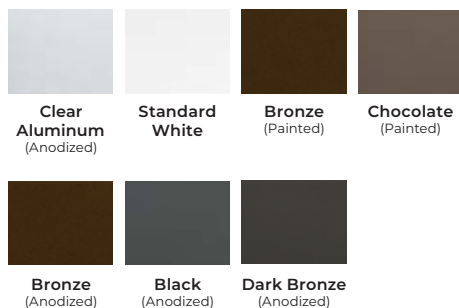

Due to the anodizing process, color variation may occur. The use of "Bronze (Painted)" is recommended for a more consistent bronze finish color. Custom colors available. Clear Aluminum complements the color of the Metal Inlay doors. Other colors are designed to complement design aspects of the home.

DOOR DESIGNS

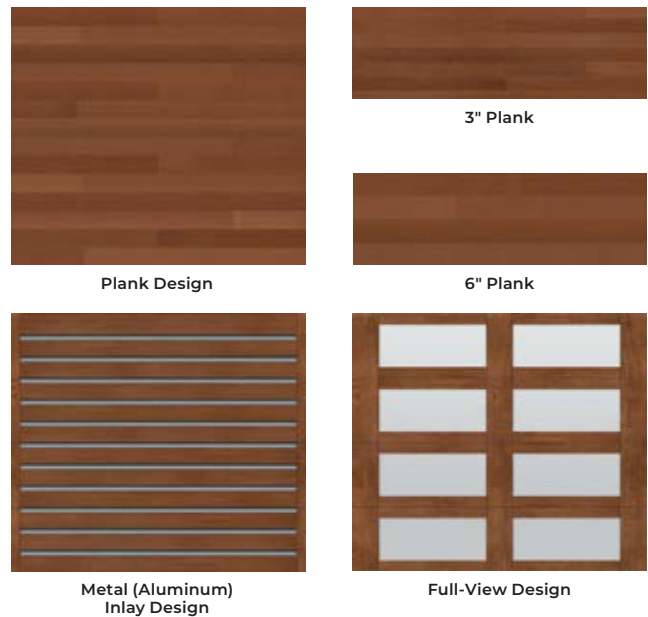

WINDOWS OPTIONS

Available only on Plank door designs.



Both window sizes are available on single car and double car doors.

PLANK WINDOW CONFIGURATIONS



NOTE: Configurations are illustrated from outside garage. When ordering, window locations are identified from inside garage looking out. Please keep in mind to avoid windows ordered in incorrect location.

MATERIAL DESIGN OPTIONS



COLORS

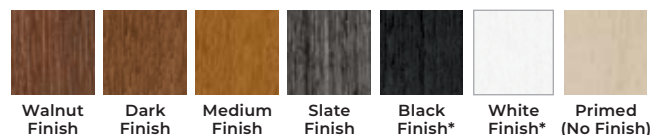

*Black and White Finish available only on Mahogany cladding and overlays. Doors can be ordered primed for those homeowners wishing to custom paint or stain their doors. Door stain color will vary slightly within a door due to finishing process. Due to the printing process, colors may vary.

SETTLERS®

SETTLERS® doors provide a traditional carriage house appearance with upward-acting functionality and durable construction.

FOUR-LAYER CONSTRUCTION



Polyurethane or Polystyrene Insulation



**CARRIAGE HOUSE DESIGNS
DURABLE, RELIABLE CONSTRUCTION**

Settlers® SF22 with SQ23 Windows

CONSTRUCTION AND FINISH

- Base door has a natural woodgrain texture, painted with a baked-on primer and polyester top coat.
- Detailed beveled, coped-edge overlay.
- Windows with complete overlay and true arch designs are available in double strength, frosted, seeded, obscure, rain and insulated glass. Grilles are removable for ease of cleaning.
- Includes automatic opener reinforcement.
- EZ-Set® torsion springs standard on most sizes.
- SXU models have 2" Intellicore® polyurethane insulation (18.4 R-value).
- SX models have 2" polystyrene insulation (9.0 R-value).
- SF models have 1-3/8" polystyrene insulation (6.5 R-value).
- For doors being painted black and very dark colors (having an LRV of 12 or less) contact Holmes for special product. For colors having an LRV of 13 to 38 we require the use of tested and approved paints. For more information call our Consumer Services Hotline at 1-800-557-0488.

WARRANTIES

PAINT SYSTEM LIMITED WARRANTY LIFETIME	WINDOW/OVERLAY DISCOLORATION LIMITED WARRANTY 10 YEAR	OVERLAY DELAMINATION LIMITED WARRANTY 5 YEAR	HARDWARE LIMITED WARRANTY 5 YEAR
--	---	--	--

DECORATIVE HARDWARE

INCLUDED

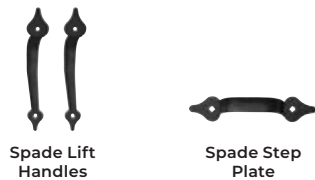

OPTIONAL



Additional hardware options are available; see pages 26-27.

DOOR DESIGNS

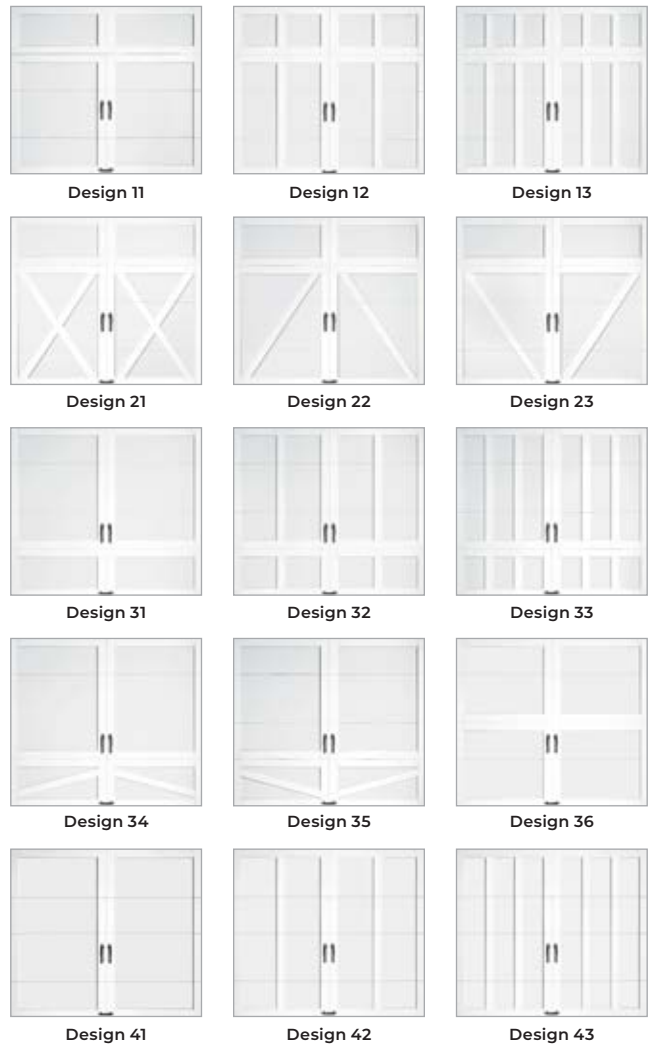

WINDOWS/TOP SECTION OPTIONS

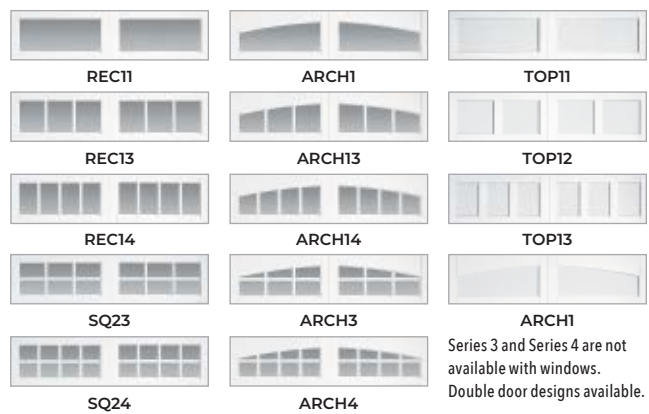

BASE DOOR/OVERLAY COLOR OPTIONS



Note: Door and overlay colors can be mixed and matched. Due to the printing process, colors may vary.

ARTISTRY® STEEL

ARTISTRY® STEEL doors create an authentic carriage house look at an affordable price.

THREE, TWO & ONE-LAYER CONSTRUCTION

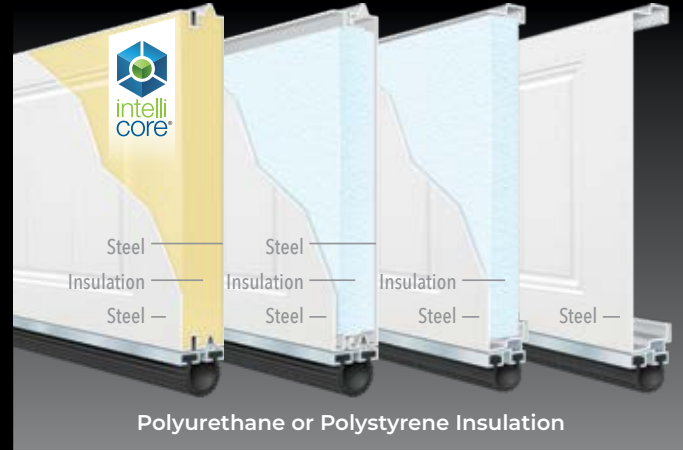

CARRIAGE HOUSE DESIGNS DURABLE STEEL CONSTRUCTION

Artistry® Steel AR2SP in Standard White with REC14 Windows

CONSTRUCTION AND FINISH

- Grooved-panel steel carriage house designs available in short and long-panel options.
- Available in 3, 2 or 1-layer construction options.
- Insulation options include 2" or 1-3/8" Intellicore® polyurethane, 2" or 1-3/8" polystyrene or 1-5/16" vinyl backed polystyrene.
- Insulated door R-values range from 6.3 to 18.4.
- 14 factory finish paint colors available, including Almond, Black, Ultra-Grain® Oak Walnut Finish and more.
- Multiple glass options available including acrylic, insulated, frosted, seeded, rain and obscure options.
- The steel skins are protected by the use of a tough, layered coating system, which includes a hot-dipped galvanized layer and baked-on primer and top coat.
- Window grilles for easy cleaning.
- WindCode® reinforcement product available for high wind load applications.
- All models can be painted to match your home's exterior. Please visit <http://info.garagedoors.com/lrv> for paint instructions on Intellicore® insulation models.

WARRANTIES

PAINT SYSTEM LIMITED WARRANTY	PAINT SYSTEM LIMITED WARRANTY	WINDOWS LIMITED WARRANTY	HARDWARE/SPRINGS LIMITED WARRANTY
LIFETIME	15 YEAR	10 YEAR	3 YEAR
AR2SU/AR2LU AR1SU/AR1LU AR2SP/AR2LP AR1SP/AR1LP AR4SV/AR4LV AR4S/AR4L	AR5SV/AR5S	ALL MODELS	ALL MODELS

DECORATIVE HARDWARE

INCLUDED



Spade Lift Handles



Spade Step Plate

OPTIONAL



Spade Strap Hinge



Keylocks



Escutcheon Plates

Additional hardware options are available; see pages 26-27.

DOOR DESIGNS

Single door width shown

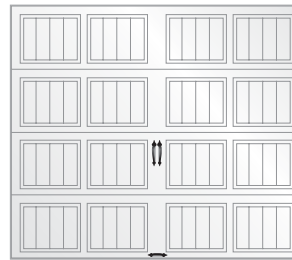

Three-Layer
AR2SU, AR1SU,
AR2SP, AR1SP

Two-Layer
AR4SV, AR5SV

One-Layer
AR4S, AR5S

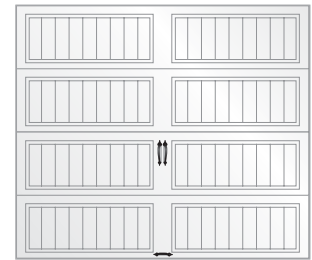

Three-Layer
AR2LU, AR1LU,
AR2LP, AR1LP

Two-Layer
AR4LV

One-Layer
AR4L

WINDOWS/TOP SECTION OPTIONS

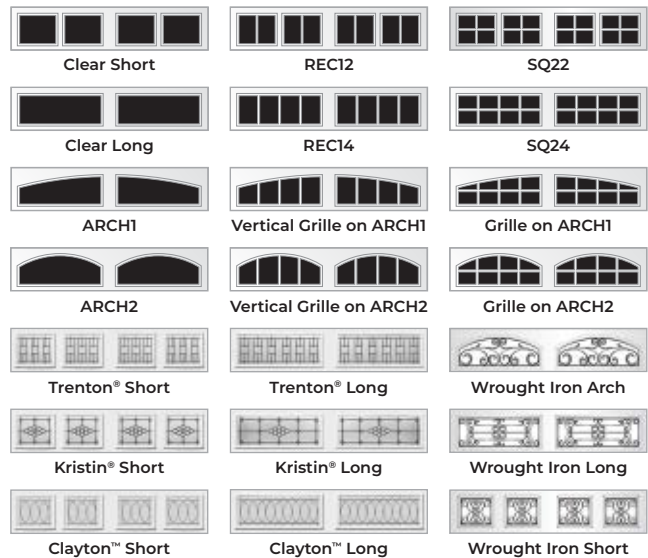

Double door designs available.

Acrylic windows require special cleaning. Never use products that contain ammonia or petroleum products to clean acrylic. Please visit holmesgaragedoor.com/acrylic for complete details.

COLOR OPTIONS



*Not available on all models; contact customer service for availability.

†Popular in select markets, Glacier White is a brighter white. Due to the printing process, colors may vary.

WESTPORT™ STEEL

WESTPORT™ STEEL doors combine the traditional symmetry of wood stile and rail door designs with the proven durability of steel construction.

THREE-LAYER CONSTRUCTION

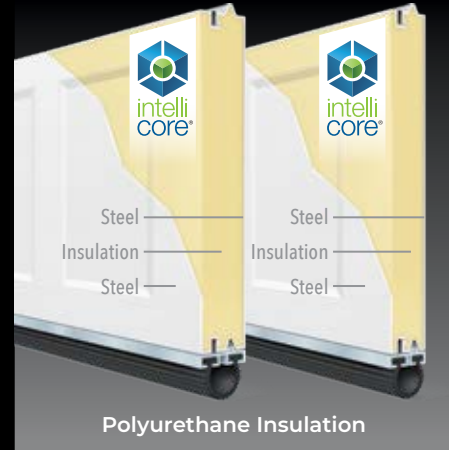

**RECESSED PANEL DESIGNS
DURABLE STEEL CONSTRUCTION**

Westport™ Steel PR2NU in Standard White with Clear Long Windows

CONSTRUCTION AND FINISH

- Recessed-panel steel designs available in narrow and extended-panel options.
- Available in 3-layer construction options.
- Insulation options include 2" or 1-3/8" Intellicore® polyurethane.
- Insulated door R-values range from 12.9 to 18.4.
- 14 factory finish paint colors available, including Almond, Black, Ultra-Grain® Oak Walnut Finish and more.
- Multiple glass options available including acrylic, insulated, frosted, seeded, rain and obscure options.
- The steel skins are protected by the use of a tough, layered coating system, which includes a hot-dipped galvanized layer and baked-on primer and top coat.
- Window grilles for easy cleaning.
- WindCode® reinforcement product available for high wind load applications.
- All models can be painted to match your home's exterior. Please visit <http://info.garagedoors.com/lrv> for paint instructions on Intellicore® insulation models.

WARRANTIES

PAINT SYSTEM LIMITED WARRANTY LIFETIME ALL MODELS	WINDOWS LIMITED WARRANTY 10 YEAR ALL MODELS	HARDWARE/SPRINGS LIMITED WARRANTY 3 YEAR ALL MODELS
--	--	--

DECORATIVE HARDWARE

INCLUDED



Color-Matched Lift Handles

OPTIONAL



Spade Lift Handles



Spade Step Plate



Keylocks



Spade Strap Hinge



Escutcheon Plates

Additional hardware options are available; see pages 26-27.

DOOR DESIGNS

Single door width shown



Narrow Panel
Three-Layer
PR2NU, PR1NU



Extended Panel
Three-Layer
PR2EU, PR1EU

WINDOWS/TOP SECTION OPTIONS

Clear Short	REC12	SQ22
Clear Long	REC14	SQ24
ARCH1	Vertical Grille on ARCH1	Grille on ARCH1
ARCH2	Vertical Grille on ARCH2	Grille on ARCH2
Trenton® Short	Trenton® Long	Wrought Iron Arch
Kristin® Short	Kristin® Long	Wrought Iron Long
Clayton™ Short	Clayton™ Long	Wrought Iron Short

Double door designs available.

Acrylic windows require special cleaning. Never use products that contain ammonia or petroleum products to clean acrylic. Please visit holmesgaragedoor.com/acrylic for complete details.

COLOR OPTIONS

Standard White	Glacier White†	Almond	Desert Tan	Sandtone
Bronze*	Chocolate*	Mocha Brown*	Charcoal*	Black*
Ultra-Grain® Oak Medium Finish*	Ultra-Grain® Oak Dark Finish*	Ultra-Grain® Oak Walnut Finish*	Ultra-Grain® Oak Slate Finish*	

*Not available on all models; contact customer service for availability.

†Popular in select markets, Glacier White is a brighter white. Due to the printing process, colors may vary.

LOGGEWOOD® SEMI-CUSTOM

LOGGEWOOD® SEMI-CUSTOM combines authentic wood designs with the functionality of an upward-acting sectional door.

HANDCRAFTED TWO-LAYER CONSTRUCTION



EXTRAORDINARY CRAFTSMANSHIP
IMPRESSIVE APPEARANCE

Lodgewood® Semi-Custom Design 2 with SQ24 Windows

CONSTRUCTION AND FINISH

- Handcrafted, two-layer, non-insulated wood doors in authentic carriage house designs. Swing-out appearance – modern operation.
- Available in three wood species. All stain-grade wood rails, stiles and panels are made from Redwood, Cedar or Hemlock. Hemlock (paint grade and grooved) doors have Hemlock or Extira® stiles and rails with exterior grade Extira® panels.
- 1/4" thick imported Luan interior backer glued to stiles and rails.
- True divided windows are standard with 1/8" DSB glass. Specialty glass options available.
- All doors can be factory primed or finish painted White. Factory stain available for stain-grade wood species (additional cost).

WARRANTIES



DECORATIVE HARDWARE

INCLUDED

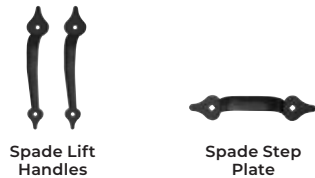

OPTIONAL

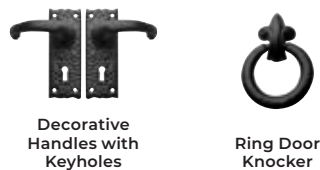

Additional hardware options are available; see pages 26-27.

OPTIONAL FACTORY STAINING*



Not all wood types stain equally and all stain colors will vary in appearance on all wood types. Variations in color will occur from printed material to actual doors, or even from door to door. *Additional cost.

Proper care and maintenance are imperative to the appearance, longevity and performance of all wood doors. Doors must be painted or stained on all six sides prior to installation. Failure to follow the installation and maintenance instructions will void the warranty. Please refer to the installation and maintenance manual for additional information about caring for a wood door.

DOOR DESIGNS

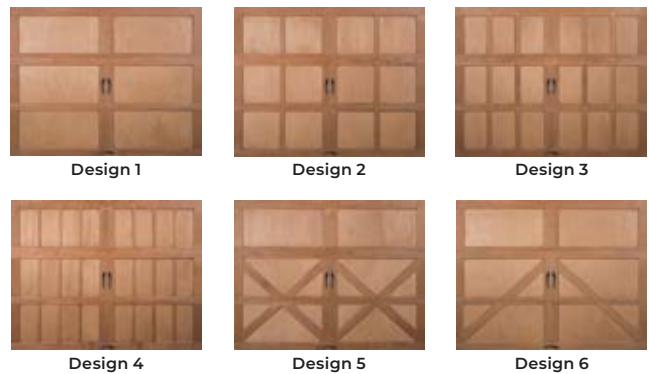

WINDOWS/TOP SECTION OPTIONS

SINGLE CAR DOOR WIDTHS

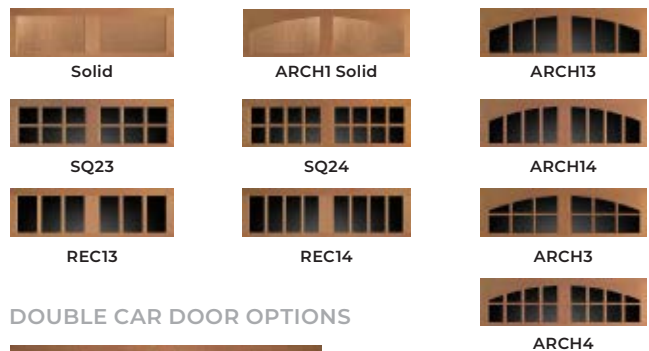

DOUBLE CAR DOOR OPTIONS

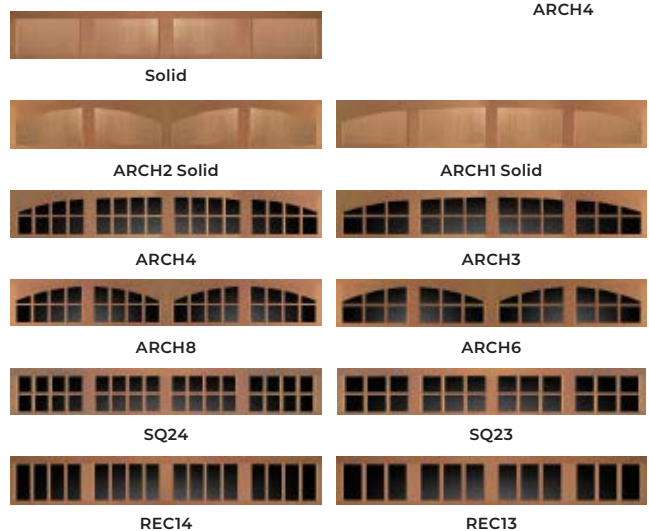

MATERIAL OPTIONS



Paint grade and grooved doors cannot be stained.



Hardware Description <i>Numbers below correspond with images on page 27</i>		Availability							
		CONTEMPORARY ALUMINUM	GLENMOOR™ CARRIAGE HOUSE 5-LAYER	GLENMOOR™ CARRIAGE HOUSE 4-LAYER	GLENMOOR™ LOUVER	GLENMOOR™ MODERN	SETTLERS	ARTISTRY™ STEEL	WESTPORT™ STEEL
1	Spade Lift Handles		✓	✓	✓	✓	✓	✓	✓
2	Spade Step Plate		✓	✓	✓	✓	✓	✓	✓
3	Spade Strap Hinge*		✓	✓	✓		✓	✓	✓
4	Twisted "L" Handles		✓	✓	✓		✓	✓	✓
5	Twisted "T" Handle						✓		
6	Escutcheon Plate(s)		✓	✓	✓		✓	✓	✓
7	Spear Lift Handles		✓	✓	✓		✓	✓	✓
8	Spear Step Plate		✓	✓	✓		✓	✓	✓
9	Spear Strap Hinge*		✓	✓	✓		✓	✓	✓
10	Colonial Lift Handles		✓	✓	✓		✓	✓	✓
11	Colonial Step Plate		✓	✓	✓		✓	✓	✓
12	Colonial Strap Hinge*		✓	✓	✓		✓	✓	✓
13	Decorative Handles with Keyhole		✓	✓	✓		✓		✓
14	Ring Door Knocker		✓	✓	✓		✓		✓
15	Aluminum Grip Handles	✓				✓			
16	Color-matched Lift Handles							✓	

* Door may not open properly if installed near the top depending on opening dimensions and lift type.

DECORATIVE HARDWARE

Attractive black powder coated handles and step plates are provided standard on select Holmes garage doors to further enhance the design of the door. Optional decorative hardware, including handles, operable L-keylocks and strap hinges, is also available.

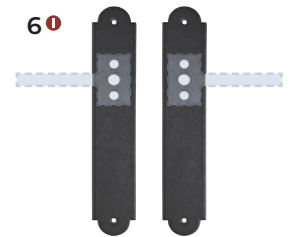
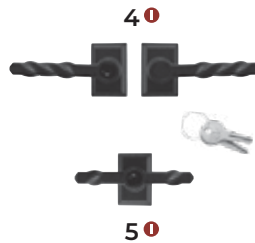

*Complements Spade Lift Handles and Spade Step Plate.

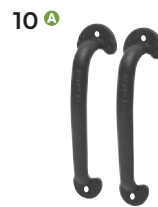

- S = Steel Construction
- I = Cast Iron Construction
- A = Aluminum Construction
- P = Color-matched Plastic Construction

STANDARD STEEL GOLD

Three-layer construction provides maximum energy efficiency, the quietest operation and superior durability.

THREE-LAYER CONSTRUCTION

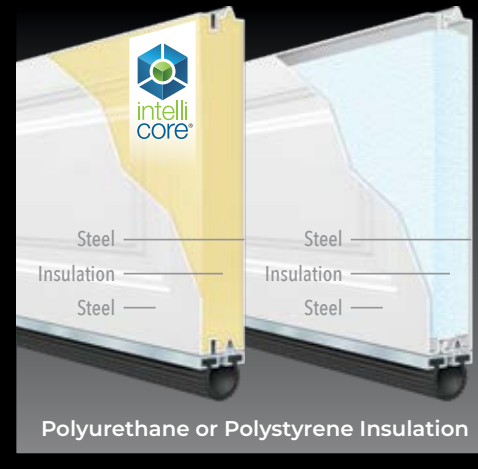

STEEL + INSULATION + STEEL

7203 in Charcoal with Madison 611 Windows

CONSTRUCTION AND FINISH

- Elegant raised and long panel designs for improved curb appeal.
- Three-layer construction provides maximum energy efficiency, the quietest operation and superior durability.
- Prefinished, stucco textured flush interior for beauty inside and out.
- 7200 and 7203 have 2" thick Intellicore® polyurethane insulation (18.4 R-value).
- 7130 and 7133 have 1-3/8" thick Intellicore® polyurethane insulation (12.9 R-value).
- 6200 and 6203 have 2" thick polystyrene insulation (9.0 R-value).
- 6130 and 6133 have 1-3/8" thick polystyrene insulation (6.5 R-value).
- All models can be painted to match your home's exterior. Please visit <http://info.garagedoors.com/lrv> for paint instructions on Intellicore® insulation models.

DOOR DESIGNS



Elegant Raised Panel – Models 7200, 7130, 6200 and 6130



Elegant Long Panel – Models 7203, 7133, 6203 and 6133



Decorative panel edging and natural embossed woodgrain texture improve appearance close-up and from the curb.

WARRANTIES



COLOR OPTIONS



* Not available on all models; contact customer service for availability.

† Popular in select markets, Glacier White is a brighter white.

Due to the printing process, colors may vary.

WINDOWS



Clear



Designer Inserts



Architectural Series*

*Not available on Models 6130 and 6133.
Additional window designs available;
see pages 32-33.

STANDARD STEEL SILVER & BRONZE

Residential garage doors are available with or without insulation.

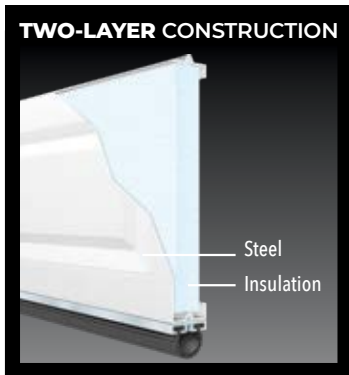

CONSTRUCTION AND FINISH

- Two-layer construction for energy efficiency and enhanced durability.
- Thick vinyl-backed polystyrene insulation for added energy efficiency.
- 5500 and 5503 have 1-5/16" thick polystyrene insulation (6.3 R-value).



CONSTRUCTION AND FINISH

- One-layer steel construction is durable and economical.
- Traditional raised and long panel designs for improved curb appeal.
- Woodgrain textured short and long raised panel designs complement traditional home styles.

DOOR STYLES



Traditional Raised Panel – Models 5500, 4200



Traditional Long Panel – Models 5503, 4203

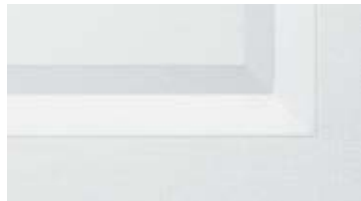

Decorative panel edging and natural embossed woodgrain texture improve appearance close-up and from the curb.

COLOR OPTIONS



Standard White Almond Desert Tan Sandtone Chocolate

Due to the printing process, colors may vary.

WINDOWS



Clear



Designer Inserts

Additional window designs available; see pages 32-33.

WARRANTIES



5500/5503



4200/4203



ALL MODELS



ALL MODELS

RESIDENTIAL TRACK OPTIONS

Determine the right track option for your new residential garage door from the options below.

STANDARD RADIUS

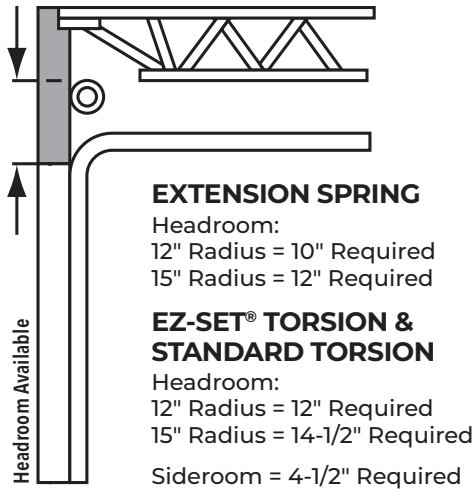

LOW HEADROOM FRONT MOUNT

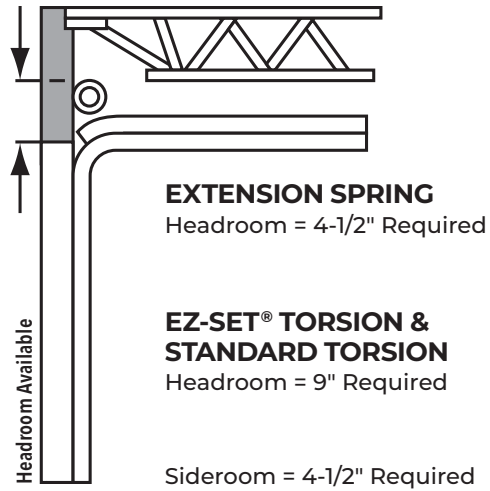

HIGH LIFT

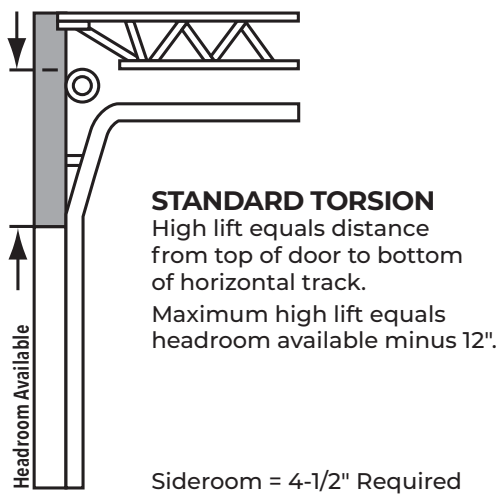

LOW HEADROOM REAR MOUNT

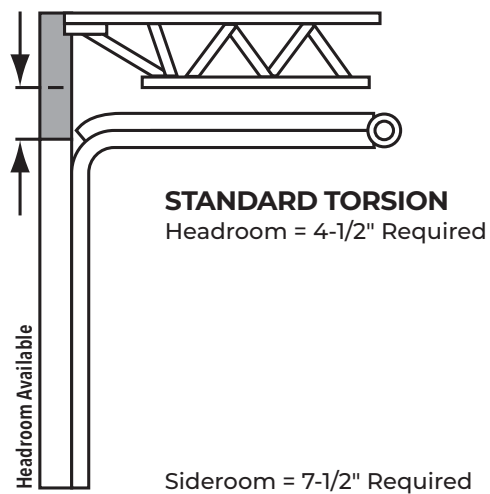

Headroom = Top of door to nearest obstruction (truss, ceiling or light fixture).
 Up to 3" of additional headroom may be required for a trolley door opener.

NOTE: Dimensions listed cover the most common applications on doors up to 8'0" high using 2" track.

WINDOW SELECTION GUIDE

Add a personal touch with designer window lites.
Available on Contemporary Steel, Standard Steel GOLD, SILVER and BRONZE.

CLEAR

Single pane, double-strength glass.



Short



Long

DESIGNER INSERTS

Dress up our clear windows with our UV-protected, color-matched Designer Inserts. They simply snap in over our clear window.



Charleston 508



Charleston 608



Colonial 509



Stockton 612



Sunset 502 (7', 7'6", 12' widths only)



Prairie 510



Prairie 610



Sunset 501 (8', 9', 12', 16', 17', 18', 20' widths only)



Madison 611



Sunset 503 (8', 9', 16', 17', 18' widths only)



Madison Arch 613



Sunset 504 (14', 15', 15'6" widths only)



Sunset 601



Sunset 505 (16', 17', 18' widths only)



Sunset 603



Sunset 506 (10', 20' widths only)



Sunset 605 (15', 16', 17', 18' widths, long panel doors only)

Designer Insert Series Windows are available on Contemporary Steel Models 7201, 7131, 6201, 6131 and all Standard Steel Gold, Silver and Bronze Models.

ARCHITECTURAL SERIES

For a larger viewing area, choose our Architectural Series options.



Clear Short



REC12



SQ22



Clear Long



REC14



SQ24



ARCH1



Vertical Grille on ARCH1



Grille on ARCH1



ARCH2



Vertical Grille on ARCH2



Grille on ARCH2



Trenton® Short



Trenton® Long



Wrought Iron Short*



Kristin® Short



Kristin® Long



Wrought Iron Long*



Clayton™ Short



Clayton™ Long



Wrought Iron Arch*

*Available non-insulated only.

Architectural Series Windows are not available on Contemporary Steel Model 6131, Standard Steel Gold Models 6130 and 6133, Standard Steel Silver or Bronze.

Acrylic windows require special cleaning. Never use products that contain ammonia or petroleum products to clean acrylic. Please visit holmesgaragedoor.com/acrylic for complete details.

CONTEMPORARY SLIM

Contemporary Slim windows are designed to further enhance the clean aesthetic common to modern architecture. Contemporary Slim windows are 37" x 8" with aluminum frames available in anodized silver or powder coated black.

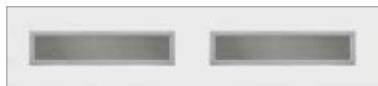

378SV - Silver



378BK - Black

Available only on Contemporary Steel Models 7208, 7209, 6208 and 6209.

Glass is available in different designs depending on door model. Options include, acrylic, clear, frosted, seeded, obscure and rain, as well as insulated versions for a more energy efficient door.



Clear



Frosted

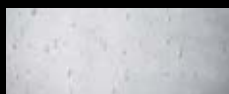

Seeded



Obscure

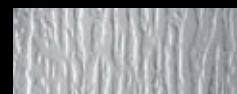

Rain

See page 35 for specialty glass options.

RESIDENTIAL GLASS OPTIONS

Glass is available in different designs depending on door model. Options include acrylic, clear, frosted, seeded, obscure, narrow reed and rain, as well as insulated versions for a more energy efficient door.



Glenmoor™ Carriage House
5-Layer with Seeded Glass

GLENMOOR™, SETTLERS®, ARTISTRY® STEEL AND WESTPORT™ STEEL



Frosted



Seeded



Obscure



Rain

STANDARD STEEL GOLD, SILVER AND BRONZE



Frosted



Seeded



Obscure



Rain

CONTEMPORARY STEEL



Tempered Frosted



Tempered Obscure



Tempered Narrow Reed



Tempered Rain

LODGEWOOD® SEMI-CUSTOM



Frosted



Seeded



Obscure



Narrow Reed



Rain



Frosted Gluechip



Delta Frost

Seeded not available on Glenmoor™ Modern, Standard Steel Silver and Standard Steel Bronze.
Additional charges for optional glass apply.

COMMERCIAL STEEL GOLD

Three-layer construction provides a durable, quiet and energy-efficient door for your commercial applications.

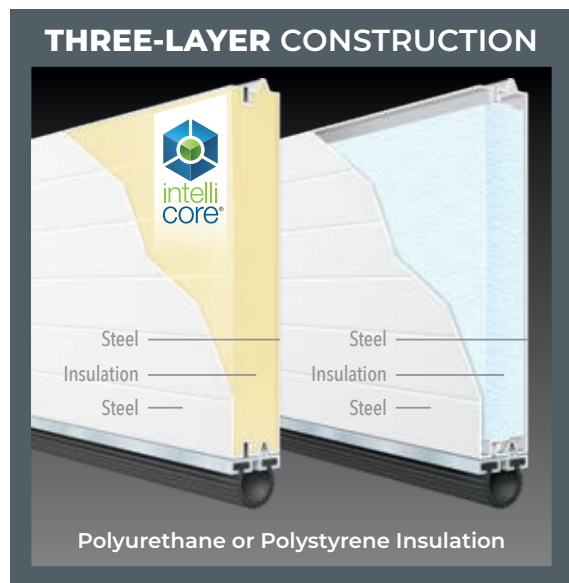

CONSTRUCTION AND FINISH

- 2" or 1-3/8" thick Intellicore® polyurethane insulation (18.4, 12.9 R-values, respectively).
- 2" or 1-3/8" thick polystyrene insulation (9.0, 6.5 R-values, respectively).
- Insulation is pressure bonded between two layers of steel.
- Superior strength and durability.
- Maximum energy efficiency and quietest operation.
- Two panel styles and thirteen colors available.
- Commercial-duty rollers.
- Heavy-duty commercial track, hardware and springs.

WINDOWS



24" x 8"



24" x 12"



Full-Vision Section



Clear Short

See pages 32-33 for additional window availability.



DOOR STYLES



Holmes 240U, 240, 210U, 210 Shallow Ribbed Panel



Holmes 250G, 230G Elegant Raised Panel

COLOR OPTIONS



Due to the printing process, colors may vary.
Colors not available on all models; contact customer service for availability.

COMMERCIAL STEEL SILVER & BRONZE

Commercial ribbed doors are available with or without insulation.



CONSTRUCTION AND FINISH

- 1-3/8" thick polystyrene insulation (6.6 R-value) is behind an exterior steel skin.
- Added energy efficiency.
- Commercial-duty rollers.
- Heavy-duty commercial track, hardware and springs.



CONSTRUCTION AND FINISH

- Durable and economical steel construction.
- Commercial-duty rollers.
- Heavy-duty commercial track, hardware and springs.



DOOR STYLES



Holmes 224V, 224S, 225V, 225S Deep Ribbed Panel



Holmes 224, 225 Deep Ribbed Panel

COLOR OPTIONS



Standard White Commercial Tan Chocolate Gray Trinar® White

Due to the printing process, colors may vary.
Colors not available on all models; contact customer service for availability.

WINDOWS



24" x 6"



24" x 12"



Full-Vision Section

COMMERCIAL TRACK OPTIONS

Determine the right track option for your new commercial garage door from the options below.

STANDARD RADIUS

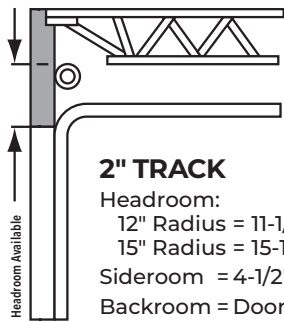

2" TRACK
 Headroom:
 12" Radius = 11-1/2" Required
 15" Radius = 15-1/2" Required
 Sideroom = 4-1/2" Required
 Backroom = Door Height
 Plus 23" Required

3" TRACK
 Headroom = 16-1/2" Required
 Sideroom = 5-1/2" Required
 Backroom = Door Height
 Plus 25" Required

LOW HEADROOM FRONT MOUNT

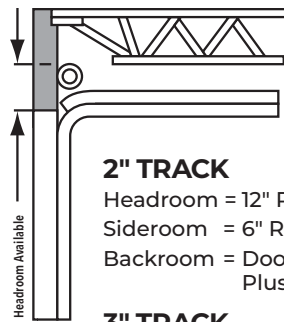

2" TRACK
 Headroom = 12" Required
 Sideroom = 6" Required
 Backroom = Door Height
 Plus 23" Required

3" TRACK
 Headroom = 14-1/2" Required
 Sideroom = 6-1/2" Required
 Backroom = Door Height
 Plus 25" Required
 (1,200 lb. limit on door weight)

LOW HEADROOM REAR MOUNT

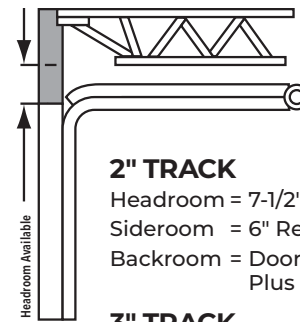

2" TRACK
 Headroom = 7-1/2" Required
 Sideroom = 6" Required
 Backroom = Door Height
 Plus 30" Required

3" TRACK
 Headroom = 8-1/2" Required
 Sideroom = 6-1/2" Required
 Backroom = Door Height
 Plus 32" Required
 (800 lb. limit on door weight)

VERTICAL LIFT

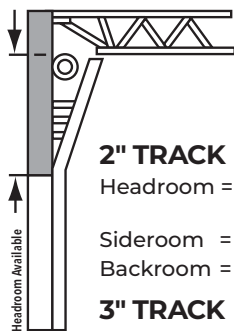

2" TRACK
 Headroom = Door Height
 Plus 12" Required
 Sideroom = 4-1/2" Required
 Backroom = 23" Required

3" TRACK
 Headroom = Door Height
 Plus 12" Required
 Sideroom = 5-1/2" Required
 Backroom = 23" Required

HIGH LIFT

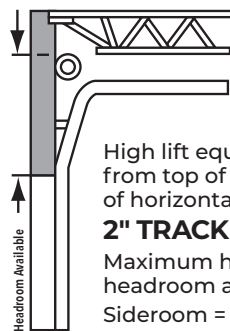

High lift equals distance from top of door to bottom of horizontal track.
2" TRACK
 Maximum high lift equals headroom available minus 12".
 Sideroom = 4-1/2" Required

3" TRACK
 Maximum high lift equals headroom available minus 14".
 Sideroom = 5-1/2" Required
 (Minimum high lift = 12" Required)

ROOF PITCH

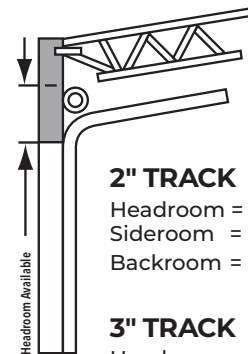

2" TRACK
 Headroom = 17" Required
 Sideroom = 4-1/2" Required
 Backroom = Door Height
 Plus 23" Required

3" TRACK
 Headroom = 18-1/2" Required
 Sideroom = 5-1/2" Required
 Backroom = Door Height
 Plus 25" Required

Headroom = Top of door to nearest obstruction (truss).

Dimensions listed cover the most common applications using standard hardware.

NOTE: Up to 4" of additional headroom may be required for a trolley door opener.



Model 270H

GOLD

- Trucking Terminals
 - Post Frame Buildings
 - Light Industrial Warehousing
 - Job Site Trailers
 - Farm Machinery Storage Sheds
 - Available in sizes 2' wide x 2' high through 18' wide x 18' high
 - Door size should match rough opening*
- *Door will arrive 7" – 8" wider than opening



Model 260H

BRONZE

- Yard Barns
 - Mini-Warehouses
 - Storage Sheds
 - Boat Houses
 - Other light-duty applications
 - Available in sizes 2' wide x 2' high through 12' wide x 14' high
 - Door size should match rough opening*
- *Door will arrive 2" – 4" wider than opening

SILICONIZED POLYESTER PAINT*

20 finishes complement any building

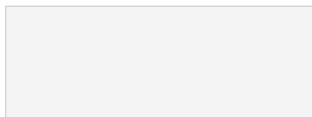

Glossy White

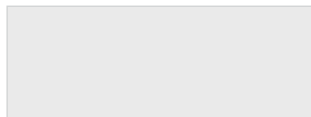

White



Silhouette Gray



Light Stone



Desert Tan



Sandstone



Bronze



Continental Brown



Cedar Red



Valentine Red



Tangerine



Sunset Orange



Marine Green



Teal



Dark Teal



Fern Green



Evergreen



Forest Green



Royal Blue



Polar Blue

*Due to the printing process, colors may vary.

MEASURING FOR YOUR NEW DOOR

Measure existing door width and height in feet and inches. This determines the size of door needed. The rough opening should be the same size as the door.

WIDTH: _____ **HEIGHT:** _____

*Common garage door widths include 8', 9', 10' and 16'.
Common garage door heights include 7' and 8'.*

Measure headroom as the distance between the top of the door and the ceiling (or first obstruction, e.g., light fixture).

HEADROOM: _____

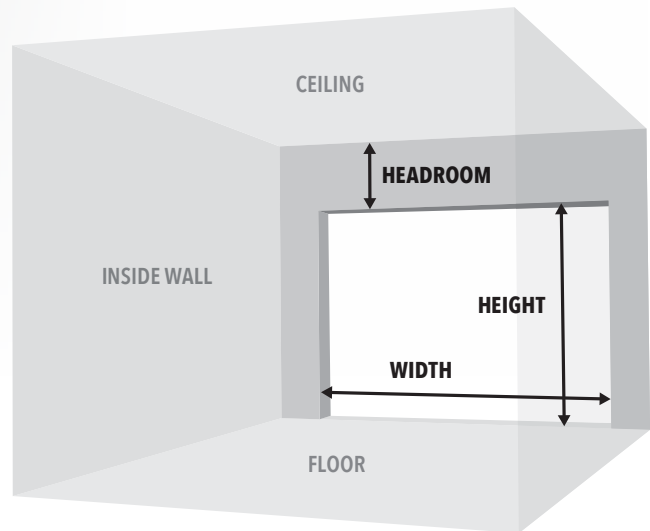

VISIT OUR WEBSITE



Visit today to order color samples, guidance on selecting the right door, installation instructions and information on maintaining your new Holmes garage door! Visit us at www.holmesgaragedoor.com or call the Holmes Helpline® at 800-557-0488

